

MICRO GROW

GREENHOUSE SYSTEMS, INC

26111 YNEZ RD., SUITE C-4, TEMECULA, CA 92591 PHONE (909)-296-3340 FAX (909)-296-3350

Revision 1.2, 02/28/02

Growcom Greenhouse Control System

INSTALLATION PROCEDURES

GROWMASTER SERIES OF CONTROLLERS

PANEL MOUNTING

Mount the control panel in an accessible location. Make sure that the location is free of vibration and in close proximity to the devices being controlled. Always consider voltage drop of electrical current when locating the control panel. Securely mount the panel.

SWITCHING CONTACTORS AND RELAYS

The control panel will operate the greenhouse equipment via load contactors and load relays. **ALL RELAYS AND LOAD CONTACTORS USED MUST HAVE A SURGE SUPPRESSOR INSTALLED ACROSS THE COIL OF THE RELAY OR LOAD CONTACTOR.** These surge suppressors are readily available from Micro Grow Greenhouse Systems, Inc. All load contactors and relays are also readily available from Micro Grow Greenhouse Systems, Inc. To decide which to use, follow this guide:

LOAD CONTACTORS: Exhaust fans, pad pumps, horizontal air flow fans, heating pumps, fan jets, large heaters, crop lighting, and all other larger electrical loads over 1/6 H.P.

LOAD RELAYS: Signal switching such as the small control lines for gas fired heaters, control lines for vent and shade system controls, small loads such as motorized shutters, other loads up to 1/6 H.P.

CUSTOM CONTACTOR AND RELAY PANEL AVAILABLE: A custom built load contactor and load relay panel is available from Micro Grow Greenhouse Systems, Inc. This panel will contain all of the required switching apparatus for your project, as well as a correctly sized machine tool transformer. Contact Micro Grow Greenhouse Systems, Inc. for pricing and availability.

TRANSFORMERS

The control panel will be powered by a 24 VAC transformer. It is most important to use a MACHINE TOOL TYPE. A Machine Tool Transformer is a heavy-duty variety that will allow for high inrush currents that are associated with the use of load contactors and relays. Micro Grow Greenhouse Systems, Inc. stocks these types of transformers. Use no smaller than a 50 VA Machine Tool Transformer. For a system that has more than three load contactors connected, use a 100 VA Machine Tool Transformer.

ELECTRICAL CIRCUITS

The electrical circuit that feeds the machine tool transformer must have no other loads connected to it. This will prevent damaging surges from other related electrical devices. Follow all local and national codes in the connection of all of the greenhouse equipment. Always allow for voltage drop conditions. Always consider that the greenhouse is a wet environment. Always follow the code rulings for disconnect switches and overcurrent devices on greenhouse equipment. **USE A QUALIFIED AND LICENSED ELECTRICIAN AT ALL TIMES.**

WIRING METHODS

Always use stranded wire when connecting cables or conductors to the actual circuit board of the control panel. This will allow flexibility. Use no smaller than #18 gauge-stranded wire for all outputs. Use no smaller than the recommended wire size of stranded cable for inputs, generally #22 gauge.

SENSOR CONDUCTORS: Route sensor conductors separately from control conductors. This is very important so as to reduce electrical interference. Never route sensor conductors in conduits used for other voltages. This is in violation of the electrical code and will cause dangerous interference to the control system. Always locate the actual sensor in the center of the range that is being controlled for accurate readings. Do not allow the sensor to come in contact with any greenhouse structure member such as a post that would give off any radiated heat and cause a false temperature reading. Do not locate the sensor where a particular piece of equipment would cause false readings, such as a heater blowing directly on the sensor. Mount all wind/rain sensor in a clear area, free of any wind obstructions.

CONTROL CONDUCTORS: Route all control conductors separately from sensor conductors. This is very important so as to reduce electrical interference. Control conductors maybe routed in conduits that contain other power system wiring only if the insulation material on the conductors is the same as the power system wiring. Consult the national electrical code or local codes if in doubt about the insulation ratings of the wire in use. Remember; always use a qualified and licensed electrician.

VENT SYSTEMS, SHADE SYSTEMS, ROLL UP CURTAINS

When connecting a vent system, shade system, or roll up curtain ventilation system to the control panel, you must use a separate control box designed for that particular vent or shade system. These are readily available from Micro Grow Greenhouse Systems, Inc. Generally these separate control boxes feature overcurrent protection for the particular motor on the vent or shade system, provisions for direct limit switch connections, and a manual means of operating the vent or shade system independent of the main control system. These separate control boxes will connect the main control system either directly through the outputs of the control system, or they will require control relays for interconnection to the main control system. Consult the individual instructions that come with the vent or shade controls for detailed information.

SYSTEM TESTING

It is always important to completely and fully test the electrical system by energizing circuits and verifying equipment operations before automatically operating the equipment from the control panel. This would include setting all of the vent and shade limit switches at the individual control panels.

GROWMASTER GROWCOM OPERATING INSTRUCTIONS

GROWCOM SERIES

The GROWCOM Series is a complete greenhouse computer system for one zone. Two sets of ventilation outputs, maintained cooling, maintained heating, air circulation, fogging outputs.

PROGRAMMING LIGHTS

RUN-Indicates that the system is in the running mode.

SET PROGRAM-All temperatures, humidity levels, and other information are set here.

SET REPORTS-This will enable the REPORT feature of the Growmaster.

SET CALIBRATION-This will put the Growmaster in the calibration mode.

SET SYSTEM-Set the clock, set the day, midday, evening, and night criteria here. Set system identifications.

SET COOLING-Set the criteria for all of the maintained cooling outputs here.

SET HEATING-Set the criteria for all of the maintained heating outputs here.

SET VENTILATION-Set the criteria for all of the staged ventilation output(s) here and the criteria for the staged shade output (if available).

SET FOGGING-Set the criteria for all of the fogging outputs here.

SET DEHUMIDIFY-Set the dehumidify functions here.

PROGRAMMING SWITCHES

There are three main programming switches located on the Growmaster front panel. These are:

RUN-SET SWITCH

RUN-Puts the control in the RUN mode.

SET-Puts the control in the SET mode in order to set all functions as outlined on the programming lights.

PRIOR-NEXT SWITCH

PRIOR-Advances to the prior item in the menu.

NEXT-Advances to the next item in the menu.

VALUE UP-VALUE DOWN SWITCH

VALUE UP-Increases the value in the display.

VALUE DOWN-Decreases the value in the display.

(The VALUE switch is also used to toggle between selected item choices available)

SET PROGRAM

The **SET PROGRAM** mode allows the grower to set all of the temperatures, humidity levels, and other settings. In this mode the normal day to day settings will be entered. No details such as time delays, differentials, etc. are entered here. Refer to the individual SET modes for the individual criteria settings.

The screen will display the first selected item to set the program on. The screen will also indicate by flashing whether the setting will apply to DAY, MIDDAY, EVENING, or NIGHT.

1. Enter the **SET PROGRAM** mode.
2. Use the **PRIOR-NEXT** switch to advance to the desired item to set.
3. Use the **VALUE** switch to increase or decrease the desired value.
4. Use the **PRIOR-NEXT** switch to advance to the next desired item to set.
5. Return to the **RUN** mode.

Cooling 1 DAY

(80) 80 80 80

Set the desired value for the flashing segment. Set for **DAY**, **MID** (Midday), **EVE** (Evening) and **NGT** (Night). You may disable the **MID AND EVE** settings in the **SET SYSTEM** mode if desired.

As you continue to toggle through the display in the **SET PROGRAM** mode, all pre-programmed features will come up for similar settings. Set all of these in the same manner as above.

RUN REPORTS

The **RUN REPORTS** mode allows the grower to run selected reports on the sensor history.

1. Enter the **RUN REPORTS** mode.
2. Use the **PRIOR-NEXT** switch to advance to the desired report.
3. Continue to use the **PRIOR-NEXT** switch to advance and view reports.

Display Report (Inside)

Select the desired report for display.

CALIBRATE

The **CALIBRATE** mode is used in order to calibrate all of the sensor readings. It is also used to calibrate the vent and shade positions in the event that they have been moved manually and do not match the GROWMASTER display as to the percentage opening. Calibration always should be done with a good thermostat or humidity indicator, and when conditions have been calm for a period of time. Late afternoon or early morning is best, without solar influence.

1. Enter the **CALIBRATE** mode.
2. Use the **PRIOR-NEXT** switch to advance to the desired item to calibrate.
3. Use the **VALUE** switch to increase or decrease the display reading.

Calibrate: Air Temp 1 80° F

Set the desired value. The calibration procedure should be done with a reliable thermometer, out of direct solar influence when calibrating temperatures. Use a wet and dry bulb to calculate humidity.

GROWMASTER GROWCOM PROGRAMMING INSTRUCTIONS

SET SYSTEM

The **SET SYSTEM** mode is used to set the system clock and date, manually view the system's sunrise and sunset times, adjust the system photocell, and to set the custom identification that will appear on the display during the run mode. Also, this mode is used to determine the times of day, either by sunrise, sunset, clock, or a combination of means, by which the four separate settings will apply. The four settings are listed as DAY, MIDDAY, EVENING, and NIGHT. In addition, the input and output configurations that have been pre-programmed into the PROCOM series control can be reviewed here. Finally, the remote ID code for use with the GROWLINK PC communications program is set here.

1. Enter the **SET SYSTEM** mode.
2. Use the **PRIOR-NEXT** switch to advance to the desired item to set.
3. Use the **VALUE** switch to increase or decrease the display reading. Also use this switch to toggle between desired choices that the system has internally provided.

Set Clk (12:00) PM
Mon 01/ 02/ 94

Set the correct time and date.

Sunrise 7:00 AM
Sunset 8:00 PM

These are the current values that the control is sensing for sunrise and sunset. There is no need to change these values; the control will update automatically.

Light Sensor
(Med) Sensitivity

Select the desired sensitivity for the photocell.

Custom System ID
(OFF)

By changing this to **PROGRAM**, you may enter a custom ID that will appear on the screen when the system is running. This may include the name of the range, or other information. If **PROGRAM** is selected, then use the **VALUE** switch to select the desired alphanumeric information, and the **PRIOR/NEXT** switch to advance to the next digit. A blank space may also be selected if desired.

DAY Mode
(At Sunrise)

Select how the four modes of operation, **DAY, MID, EVE, NGT** will be affected. You may choose a switching action **AT SUNRISE, PRE-SUNRISE**, (Sunset for EVE and NGT) or **TIMED**. You may also choose **NOT IN USE** to disable EVE and MID if desired.

Review I/O
Assignments ? (N)

Use this selection to review the assigned inputs and outputs for your system.

Remote ID Code:
(0)

Not applicable if not using the GROWLINK program. Set the ID code here for the Growlink remote PC program available from Micro Grow Greenhouse Systems Inc.

**Link Air 1
To Output (1)**

Select the output that the Air Circulation output will be linked to.

**Air 1 On if
Output is (ON)**

Select when to turn on the Air Circulation output, or, if the output is a vent or other staged device, set the stage of operation desired to energize the air circulation output.

**(IF VENT)
Air 1 On if
Output is (<=) (CL)**

SET COOLING

The **SET COOLING** mode will be used to set the desired cooling stage temperature separations and differentials. The internal time delays that will prevent rapid cycling are also set here. Also, this mode is used to determine if any of the cooling stages will be activated during the dehumidify functions of the system. You may choose either the immediate dehumidify function, or the delayed dehumidify function.

1. Enter the **SET COOLING** mode.
2. Use the **PRIOR-NEXT** switch to advance to the desired item to set.
3. Use the **VALUE** switch to toggle between desired choices that the system has internally provided.

Cooling 1 Stages (2° Sep.) 2° Dif.

Set the desired separation of the cooling stages here, and also the desired differential. The separation is the total number of degrees that separate each stage of operation. Once an output or a stage has been activated, the differential is the amount of temperature change required that will cancel the operation of that stage or output.

Cooling 1 Timing (2 Sec.)

Set the desired time delay here. The time delay will be active on both energizing and de-energizing stages.

Cooling 1 Stg (1) On Immed Dehum

Set the desired stages of operation here that will be activated by the dehumidify functions. You may choose either the **IMMEDIATE** or the **DELAYED** dehumidify functions for a particular stage.

SET HEATING

The **SET HEATING** mode will be used to set the desired heating stage temperature separations and differentials. The internal time delays that will prevent rapid cycling are also set here. Also, this mode is used to determine if any of the heating stages will be activated during the dehumidify functions of the system. You may choose either the immediate dehumidify function, or the delayed dehumidify function.

1. Enter the **SET HEATING** mode.
2. Use the **PRIOR-NEXT** switch to advance to the desired item to set.
3. Use the **VALUE** switch to toggle between desired choices that the system has internally provided.

Heating 1 Stages (2° Sep.) 2° Dif.

Set the desired separation of the heating stages here, and also the desired differential. The separation is the total number of degrees that separate each stage of operation. Once an output or a stage has been activated the differential is the amount of temperature change required that will cancel the operation of that stage or output.

Heating 1 Timing (2 Sec.)

Set the desired time delay here. The time delay will be active on both energizing and de-energizing stages.

Heating 1 Stg (1) On Immed Dehum

Set the desired stages of operation here that will be activated by the dehumidify functions. You may choose either the **IMMEDIATE** or the **DELAYED** dehumidify functions, or both, for a particular stage.

SET VENTILATION

The **SET VENTILATION** mode is used to set the number of desired stages of the vent openings, the desired position of each stage, the actual total opening time for the vent itself, and to let the system know if there is a safety time delay in the vent control panel being used. The programming also allows the vent to be linked to a cooling stage or to an override input if desired. The dehumidify functions of the vent, both immediate and timed, are programmed here. This mode also is where the vent temperature differentials and temperature stage separations are set. The vent system timing will be set here. This mode is also used to setup the total number of shade opening stages, the system timing for the shade system, the solar level differential, and a maximum closed position for the shade system. The actual total opening time for the shade system itself is entered here, and information as to a safety delay that may be present in the actual shade control panel being used is also entered here. The heat retention feature of the shade system can be programmed in this mode.

1. Enter the **SET VENTILATION** mode.
2. Use the **PRIOR-NEXT** switch to advance to the desired item to set.
3. Use the **VALUE** switch to toggle between desired choices that the system has internally provided.

Open Vent 1 In (4) Positions

Set the desired number of ventilation stages here. The system can operate the vent in up to eight separate stages. If the output is connected to a pad vent system, then enter "PAD VENT". The Growmaster Growcom will now open the pad vent with the cooling stages as they turn on.

Vent 1 Pos 1 10% Open

Set the desired percentages of opening here for each stage. The final stage will always be set to maximum vent position.

Vent 1 Max Pos (100) % Open

Set the desired maximum position for the vent.

Opening Time Vent 1 3:00

Set the actual time that the vent takes to run from its fully closed position to fully open. This time is critical, as the system will use this to determine correct openings.

Safety Delay for Vent 1 (5) SEC

If your vent control system is equipped with a time delay relay that protects the vent against false reversals, enter the number of seconds here. If you are in doubt whether your system has a time delay, simply manually energize the vent. If the vent starts to move immediately, there most likely is no time delay protection. You may choose **NONE** as one of the choices.

Link Vent 1 to Cooling Stage (NO)

Use this feature to link a set of vents to a particular cooling stage if desired. A possible use for this would be in the event that roof vents, as well as active cooling such as exhaust fans are in use. This feature will allow the user to link the roof vents to close to a low position when the cooling stages are active. This would allow the air to be drawn across the entire range and not through the roof vents by the exhaust fans. This setup is not applicable to "PAD VENT".

Vent 1 (Closed) on Cool Stage 1

If a link is made to a cooling stage, the system will then ask what vent position during that cooling stage.

**Link Vent 1 to
Override Inp (NO)**

Use this setting if any override inputs are in use. Override inputs can come from the use of a Weather Station, or other external device.

**Mx Vent Pos
on Override 1 (CL)**

If a link is made to an override input, the system will then ask what the maximum vent position should be during that override input period.

**Vent 1 Stg (1)
On Immed Dehum**

Set the desired stages of operation here that will be activated by the dehumidify functions. You may choose either the **IMMEDIATE** or the **DELAYED** dehumidify functions, or both, for a particular stage. This setup is not applicable to "PAD VENT".

**Vent 1 Stages
(2° Sep.) 2° Dif.**

Set the desired separation of the ventilation stages here, and also the desired differential. The separation is the total number of degrees that separate each stage of operation. Once an output or a stage has been activated the differential is the amount of temperature change required that will cancel the operation of that stage or output. This setup is not applicable to "PAD VENT".

**Vent 1 Timing
(2 Sec.)**

Set the desired time delay here. The time delay will be active on both energizing and de-energizing stages. This setup is not applicable to "PAD VENT".

The following instructions are for setting up the staged shade outputs. If the controller does not have any outputs labeled "SHADE 1 OPEN" or "SHADE 1 CLOSE", disregard the following instructions.

**Close Shade 1
in (4) Positions**

Set the desired number of stages here for the shade system.

**Shade 1
Delay (5 Min.)**

This will be the time delay that the system must see in order to move the shade system covered or uncovered. This will be the amount of time that the solar level must maintain in order to cause movement.

**Shade 1
Diff. (40) w/m²**

This is the differential of the shading system. This is the amount of light that is necessary in order to cause a change in the system.

**Shade 1
Max (100%) Closed**

Use this setting if it is desired not to have the shade system close to 100% at any time. Use this if the shade materials do not allow air passage and it is desired to always leave the shade system slightly open.

**Shade 1
Close Time 3:00**

Enter the actual time that it takes the shade system to go from a fully open position, to a fully closed position. This is critical as the computer will use this time to determine the shade position.

Shade 1 Safety Delay (5) Sec

If your shade control system is equipped with a time delay relay that protects the vent against false reversals, enter the number of seconds here. If you are in doubt whether your system has a time delay, simply manually energize the shade system. If the shade system starts to move immediately, there most likely is no time delay protection. You may choose **NONE** as one of the choices.

Shade 1 Heat Ret 1 (Disabled)

The shade operation offers a heat retention feature. It is possible to use the shade system as an energy curtain. If you choose to **ENABLE** this, you may then select the following choices:

- 1. Activate the Heat Retention Feature by a mode of operation (EVE, NGT, etc.)**
- 2. Activate the Heat Retention Feature if a sensor is below or above a particular setting.**

You may cancel the heat retention feature based also on the above criteria.
(There are two separate heat retention programs for the shade system)

**Go to (0) % if
Mode = Day**

Enter the percent covered that you want the shade system to go to during heat retention.

**Go to 0% if
Mode = (Day)**

Select the mode that you want the shade system to be activated for heat retention

**And
(Air Temp 1) >= 80**

Select the sensor to be used to activate the shade system for heat retention. You may also choose to ignore any sensors if you like. This will activate the system simply on modes of operation (DAY, MID, EVE, NGT)

**And
Air Temp 1 (>=) 80**

Select the condition for the sensor set point for heat retention.

**And
Air Temp 1 >= (80)**

Select the set point for the activation of heat retention.

**Cancel HeatRet 1
If Mode = (MID)**

Select the mode to cancel the heat retention.

**OR
Air Temp 1 <= (60)**

Select the temperature to cancel the heat retention.

**Max Pos (Uncov'd)
If Vent 1 Active**

Use this if the shade materials do not allow air passage and it is desired to always leave the shade system slightly open when the ventilation system is operating.

SET FOGGING

The **SET FOGGING** mode is used to set the temperature and humidity differentials and the system timing for the fogging output. The grower can also select if the fogging system should be maintained on or pulsed in this mode.

1. Enter the **SET FOGGING** mode.
2. Use the **PRIOR-NEXT** switch to advance to the desired item to set.
3. Use the **VALUE** switch to toggle between desired choices that the system has internally provided.

Fog 1 Diff. (2)^o Temp 2% RH

Set the desired differential of the fogging stage. The differential is the amount of temperature decrease that the sensor must see before turning off the fogging stage.

Fog 1 Diff. 2^o Temp (2)% RH

Set the desired differential of the fogging stage. The differential is the amount of humidity increase that the sensor must see before turning off the fogging stage.

Fog 1 Timing (2 Sec.)

Set the desired time delay here. The time delay will be active on both energizing and de-energizing stages.

Fog 1 (Maintained)

Fogging output may be commanded in two way, maintained or pulse. Maintained will turn on the output till the humidity increases into the controlling band. Pulsed will allow the grower to enter the run and wait time to more slowly increase the humidity level.

Fog 1 On (2 Sec.)

Select the desired running time for the fogging system

Fog 1 Off (2 Sec.)

Select the desired waiting time for the fogging system.

SET DEHUMIDIFY

The **SET DEHUMIDIFY** mode is used to enable or to disable the dehumidify functions of the control. The run time of the immediate and the delayed dehumidify functions are set here. The repeat time of the dehumidify feature is set here. The dehumidify differential, and the maximum heat loss and gain for the dehumidify mode are also entered here.

1. Enter the **SET DEHUMIDIFY** mode.
2. Use the **PRIOR-NEXT** switch to advance to the desired item to set.
3. Use the **VALUE** switch to toggle between desired choices that the system has internally provided.

Dehum 1 (Disabled)

You may select how to disable the dehumidify feature. Dehumidify may be disabled upon an override input. The dehumidify feature can be disabled all together if desired.

Dehum 1 Imm Run time (10) Min

Enter the time to allow Immediate Dehumidify to run.

Dehum 1 Dly Run Time (10) Min

Enter the time to allow Delay Dehumidify to run.

If Dehum Fails Repeat in (2:00) H

Enter the time to repeat the dehumidify if unable to lower the humidity.

Dehum 1 Dif. (2)% RH

Set the desired differential for dehumidify. The differential is the amount of humidity decrease that the sensor must see before disabling dehumidify.

Disable Dehum if below HtSP by (5)°

Set the maximum heat loss below the normal heating set point temperature. This will disable any cooling stages activated during dehumidify. This prevents too much heat loss in the range during dehumidify.

Disable Dehum if above HtSP by (5)°

Set the maximum heat gain above the normal heating set point temperature. This will disable any heating stages activated during dehumidify. This prevents too much heat gain in the range during dehumidify.

ALL CONNECTED 24 VAC LOAD RELAYS AND CONTACTORS MUST HAVE A SURGE PROTECTION DEVICE INSTALLED ACROSS THE COILS. SURGE SUPPRESSION DEVICES ARE AVAILABLE UPON REQUEST.

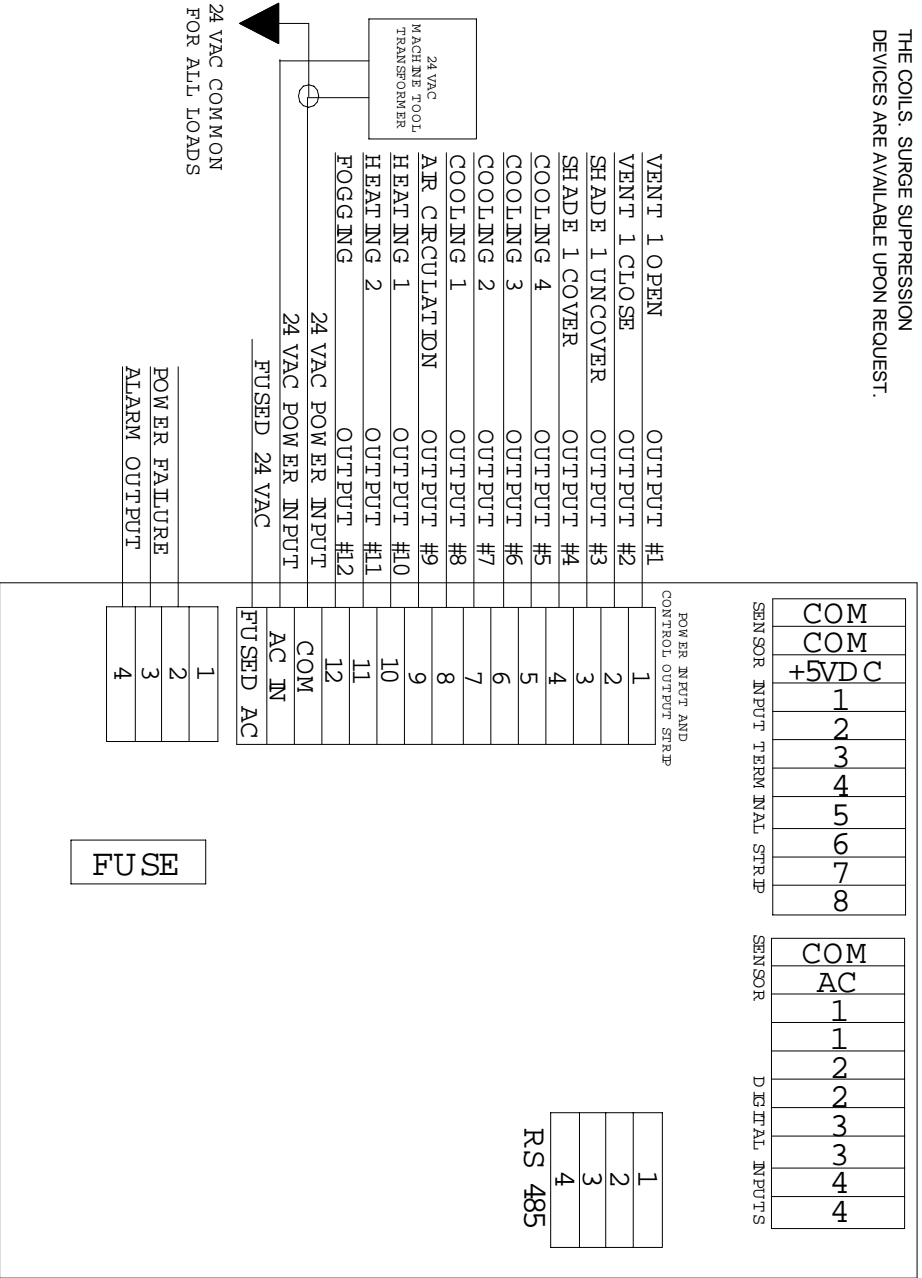

ALL CORRECT LOAD CONTACTORS AND CONTROL RELAYS ARE AVAILABLE FROM MICROGROW GREENHOUSE SYSTEMS. 50 AND 100 VA MACHINE TOOL TRANSFORMERS ARE AVAILABLE FROM MICRO GROW GREENHOUSE SYSTEMS. SEE YOUR DISTRIBUTOR OR CALL MICRO GROW FOR REQUIRED CONNECTION DEVICES AND ACCESSORIES.

GROW MASTER GROW COM OUTPUTS

TRANSFORMER NOTE:
USE A MACHINE TOOL VARIETY ONLY. 100 VA IS RECOMMENDED. IF A SMALLER SIZED TRANSFORMER IS USED, ADJUST THE FUSE PROTECTION ACCORDINGLY. (see fuse note)

FUSE NOTE:
IMPORTANT: DO NOT EXCEED 4 AMPS FOR THE FUSE RATING WHEN USING A 100 VA TRANSFORMER OR 2 AMPS WHEN USING A 50 VA TRANSFORMER. USE A SLOW BLOW VARIETY.

OUTPUT NOTE:
THE CONTROL OUTPUTS ARE RATED AT 1 AMP EACH MAXIMUM. DO NOT EXCEED THIS OR DAMAGE MAY RESULT. DO NOT EXCEED 1 AMP FOR ANY SINGLE OUTPUT OR 4 AMPS TOTAL FOR ALL OUTPUTS. (2 AMPS TOTAL IF A 50 VA TRANSFORMER IS IN USE)

M I C R O G R O W G R E E N H O U S E S Y S T E M S , I N C .
26111 Ynez Road, Suite C-4
Temecula, CA 92591
Phone 909.296.3340 Fax 909.296.3350

Project GROW COM OUTPUTS			
Drawn by GH	Date 02/28/02	Distributor N/A	Order D N/A

GROW MASTER GROW COM INPUTS

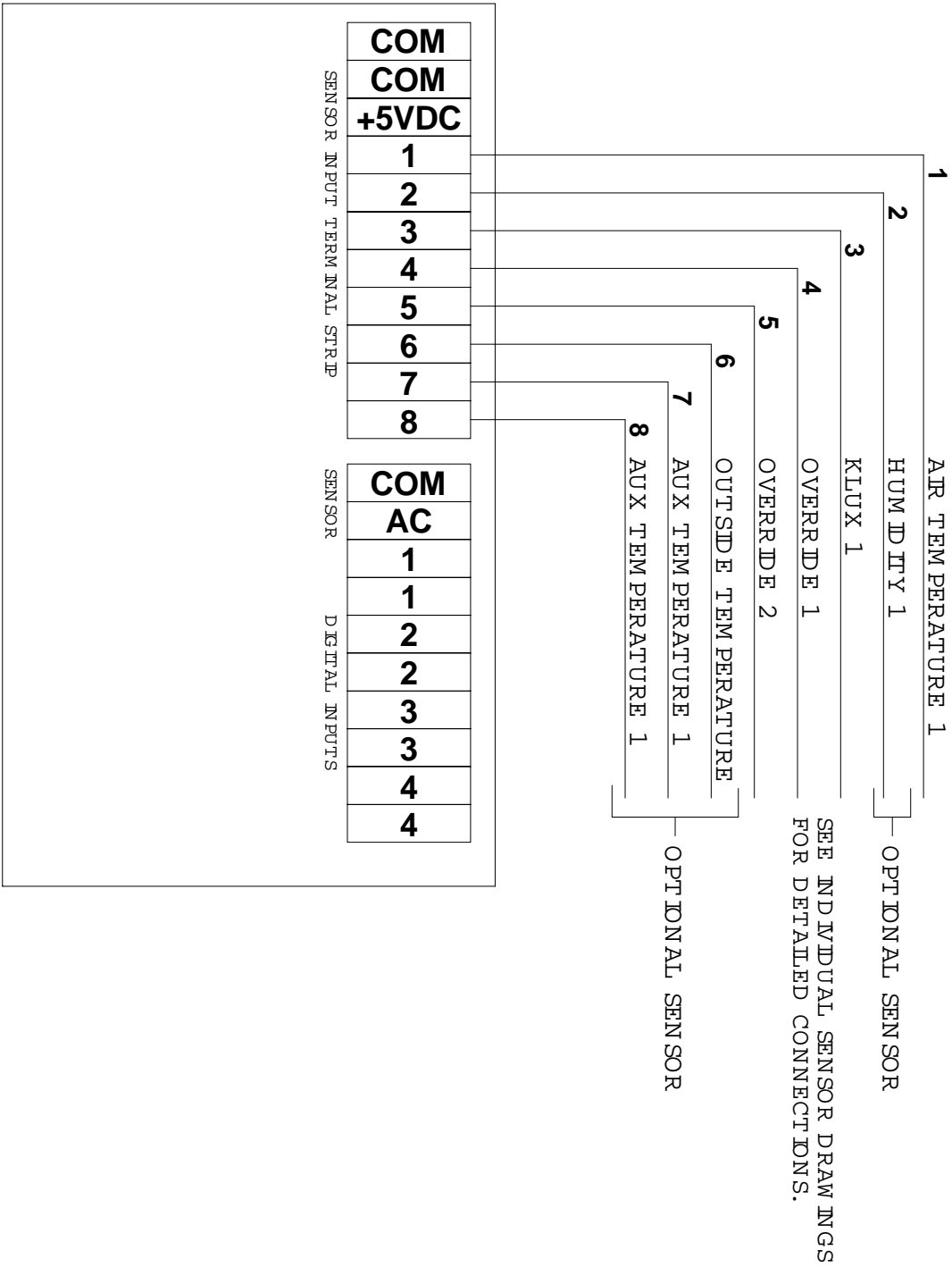

MICRO GROW GREENHOUSE SYSTEMS, INC.
 26111 Ynez Road, Suite C-4
 Temecula, CA 92591
 Phone 909.296.3340 Fax 909.296.3350

Project: GROW MASTER GROW COM INPUTS			
Drawn by: GH	Date: 02/28/02	Distributor: N/A	Order ID: N/A

AIR TEMPERATURE SENSOR

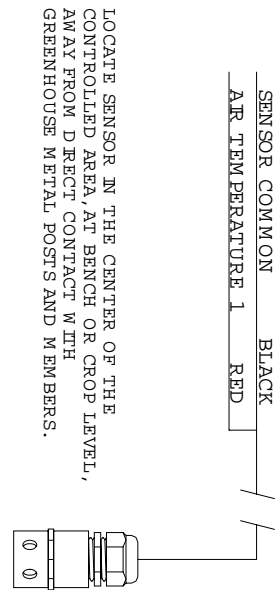

LOCATE SENSOR IN THE CENTER OF THE CONTROLLED AREA, AT BENCH OR CROP LEVEL, AWAY FROM DIRECT CONTACT WITH GREENHOUSE METAL POSTS AND MEMBERS.

KLUX SENSOR

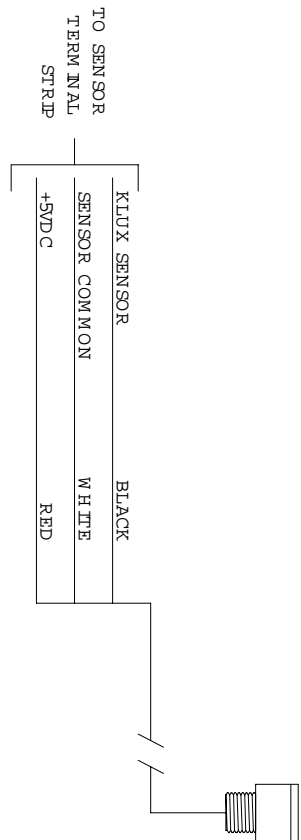

OVERRIDE INPUT

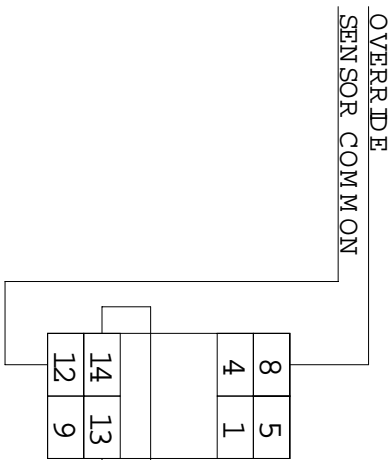

RELAY IS A DPDT
14, 13 ... 24 VAC COIL
12, 9 COMMON TERM INALS
8, 5 NORMALLY OPEN TERM INALS
4, 1 NORMALLY CLOSED TERM INALS

24 VAC FROM OVERRIDE DEVICE
SUCH AS WEATHERMASTER OR
WEATHERMATE.

GROW COM SENSORS

FORMER MICRO GROW GREENHOUSE



M I C R O G R O W G R E E N H O U S E S Y S T E M S , I N C .
26111 Ynez Road, Suite C-4
Temecula, CA 92591
Phone 909.296.3340 Fax 909.296.3350

Project G R O W C O M S E N S O R S			
Drawn by GH	Date 02/28/02	Distributor N/A	Order D N/A

NON-ASPIRATED HUMIDITY SENSOR

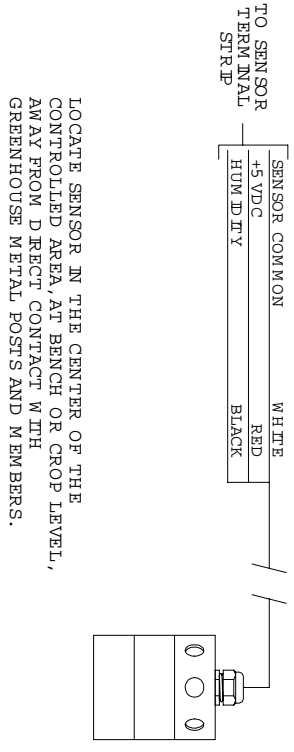

LOCATE SENSOR IN THE CENTER OF THE CONTROLLED AREA, AT BENCH OR CROP LEVEL, AWAY FROM DIRECT CONTACT WITH GREENHOUSE METAL POSTS AND MEMBERS.

NON-ASPIRATED AIR TEMPERATURE & HUMIDITY SENSOR

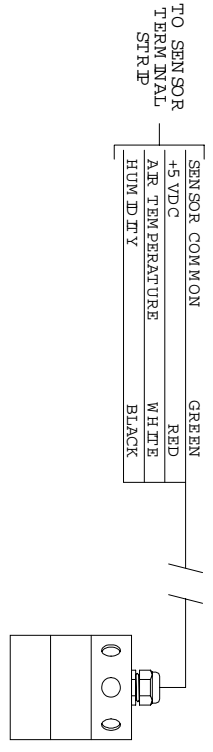

LOCATE SENSOR IN THE CENTER OF THE CONTROLLED AREA, AT BENCH OR CROP LEVEL, AWAY FROM DIRECT CONTACT WITH GREENHOUSE METAL POSTS AND MEMBERS.

OUTDOOR TEMPERATURE SENSOR

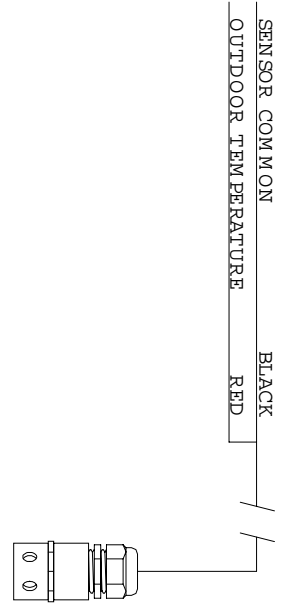

ASPIRATED AIR TEMPERATURE AND HUMIDITY SENSOR

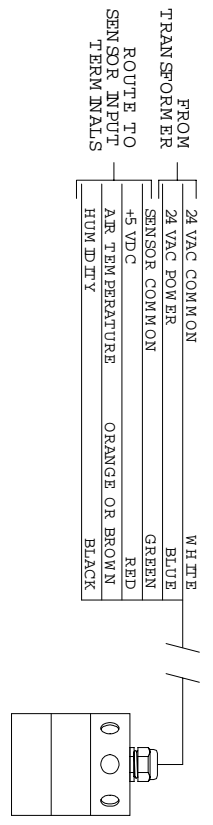

LOCATE SENSOR IN THE CENTER OF THE CONTROLLED AREA, AT BENCH OR CROP LEVEL, AWAY FROM DIRECT CONTACT WITH GREENHOUSE METAL POSTS AND MEMBERS.

GROW COM OPTIONAL SENSORS



M I C R O G R O W G R E E N H O U S E S Y S T E M S , I N C .
 26111 Ynez Road, Suite C-4
 Temecula, CA 92591
 Phone 909.296.3340 Fax 909.296.3350

Project G R O W C O M O P T I O N A L S E N S O R S			
Drawn by GH	Date 02/28/02	Distributor N/A	Order ID N/A

WIND SPEED

WIND DIRECTION

SECURELY MOUNT THE OUTDOOR
SENSOR AT THE HIGHEST UNOBSTRUCTED
POINT ON THE GREENHOUSE.

OUTDOOR
TEMP.

OBSERVE NORTH POSITIONING !

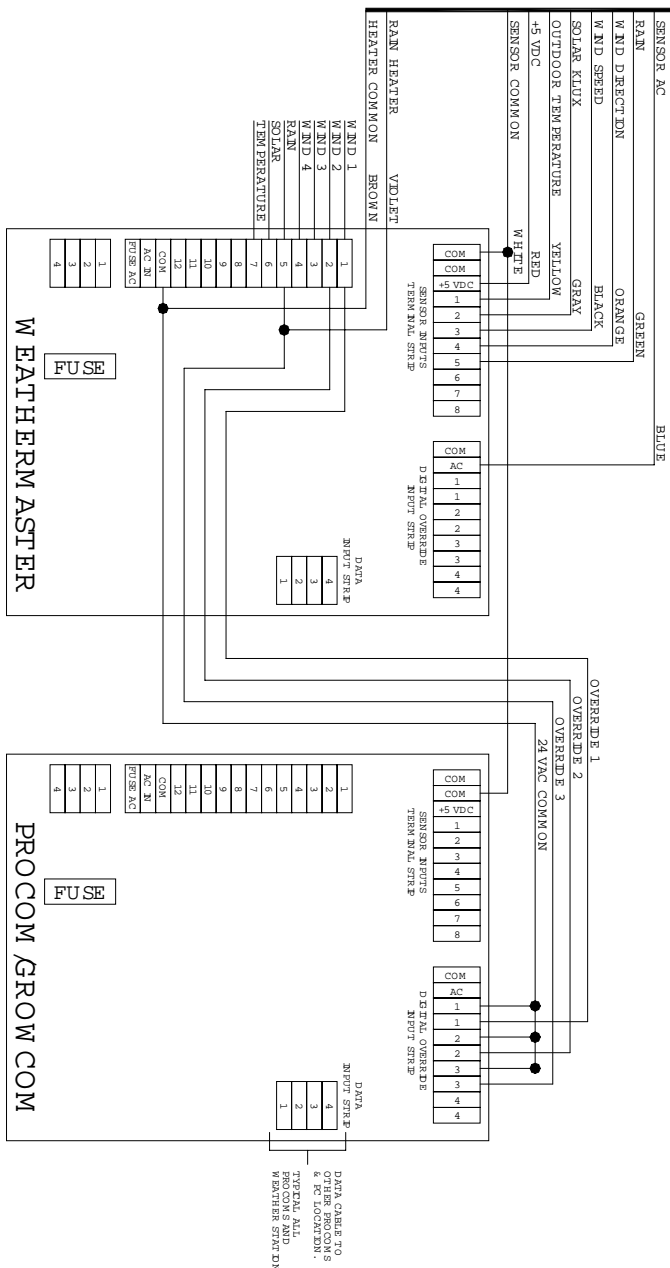
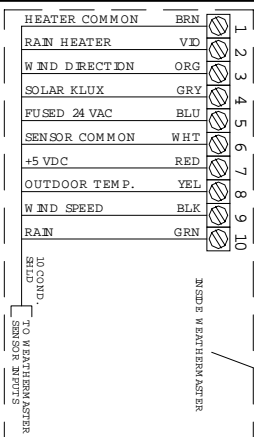

TYPICAL WEATHERMASTER
CONNECTION TO PROCOM GROW COM

NOTE:
ALL WIRE CONNECTIONS ARE TO
BE MADE AT TERMINAL STRIPS
WITHIN THE CONTROLS. DO NOT
SPlice Wires.

MICRO GROW GREENHOUSE SYSTEMS, INC.
26111 Ynez Road, Suite C-4
Temecula, CA 92591
Phone 909.296.3340 Fax 909.296.3350

Project WEATHERMASTER TO PROCOM GROW COM			
Drawn by GH	Date 02/28/02	Distributor N/A	Order ID N/A

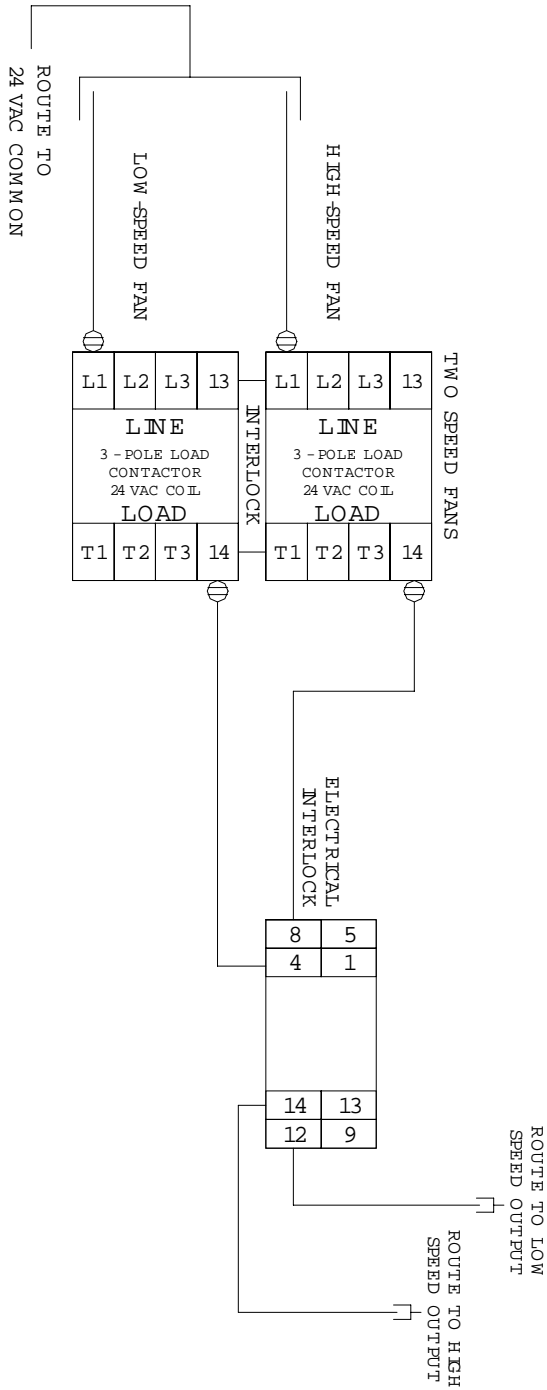

TYPICAL CONNECTION FOR 2 SPEED LOAD CONTACTOR USED FOR 2 SPEED FANS

RELAY AND LOAD CONTACTOR NOTES

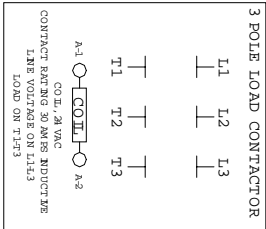
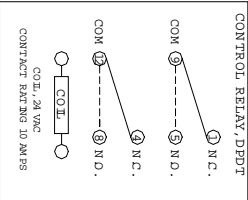

REVISION 1: SYMBOLS CORRECTED TO MEET ANSI STANDARDS

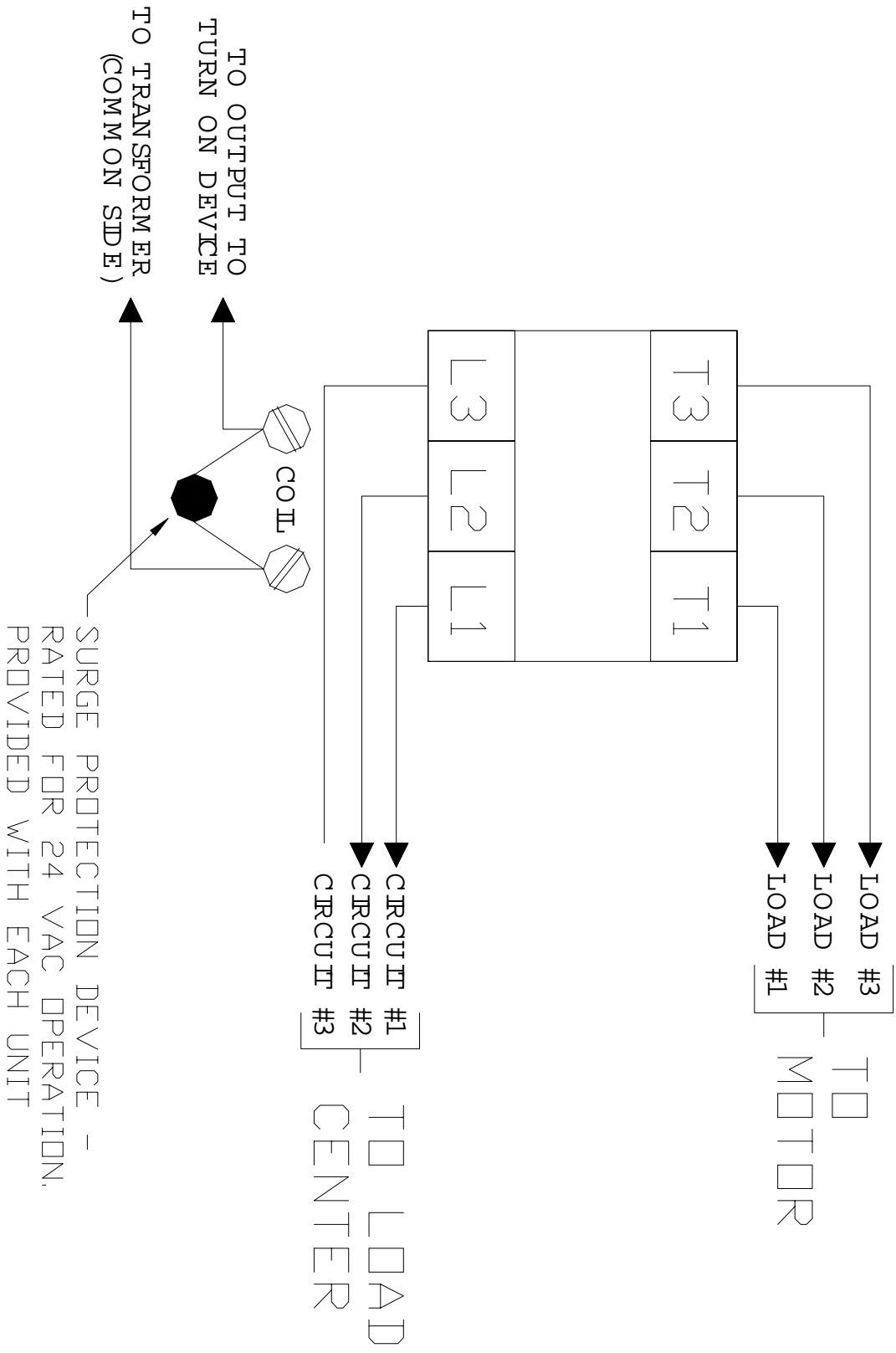

CONNECTION OF LOADS
TO A LOAD CONTACTOR.
FOR LOADS OVER 10 AMPS
AND LESS THAN 30 AMPS



MICRO GROW GREENHOUSE SYSTEMS, INC.
26111 Ynez Road, Suite C-4
Temecula, CA 92591
Phone 909.296.3340 Fax 909.296.3350

Project			
CONNECTION OF LOADS TO A LOAD CONTACTOR			
Drawn by	Date	Distributor	Order ID
GH	12/14/01	N/A	N/A

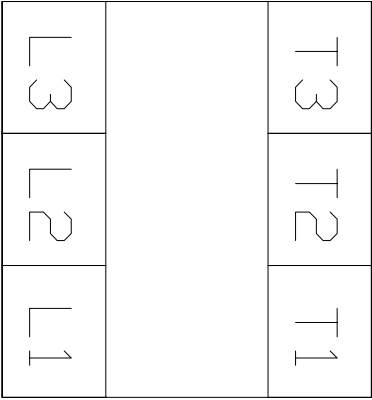

SURGE PROTECTION DEVICE -
 RATED FOR 24 VAC OPERATION,
 PROVIDED WITH EACH UNIT

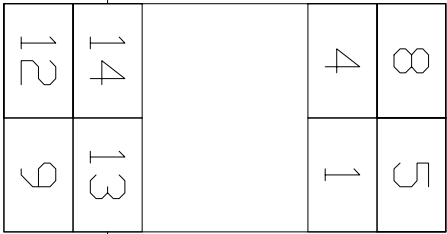

CONTACTOR NOTES:
 LINES ON 13, 12, 11
 TO ADS ON 13, 12, 11

RELAY NOTES:

RELAYS ARE DPDT
 14, 13 24 VAC COIL
 12, 9 COMMON TERM NALS
 8, 5 NO RM ALTY OPEN
 TERM NALS
 4, 1 NO RM ALTY CLOSE
 TERM NALS

INSTALLATION OF SURGE
 PROTECTION DEVICES ON
 LOAD CONTACTORS AND
 LOAD RELAYS



MICRO GROW GREENHOUSE SYSTEMS, INC.
 26111 Ynez Road, Suite C-4
 Temecula, CA 92591
 Phone 909.296.3340 Fax 909.296.3350

Project

INSTALLATION OF SURGE PROTECTION DEVICES

Drawn by
 GH

Date
 12/14/01

Distributor
 N/A

Order ID
 N/A

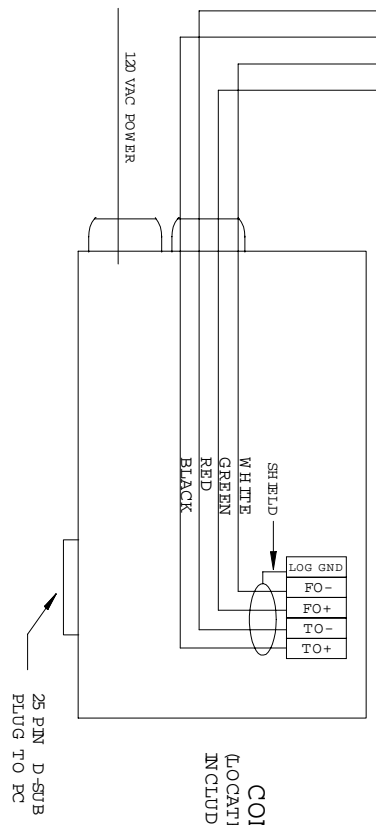
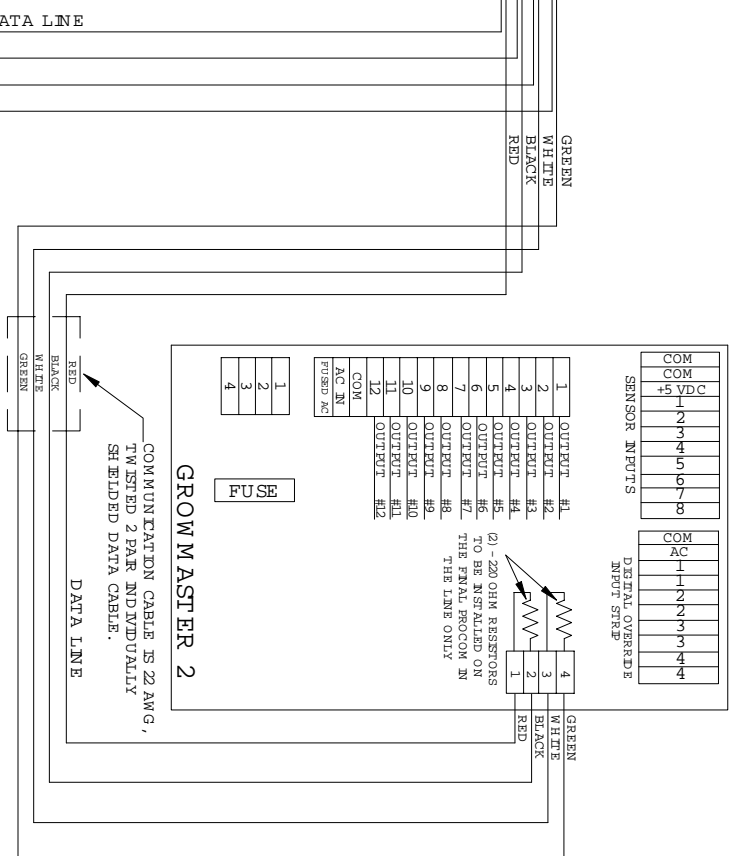
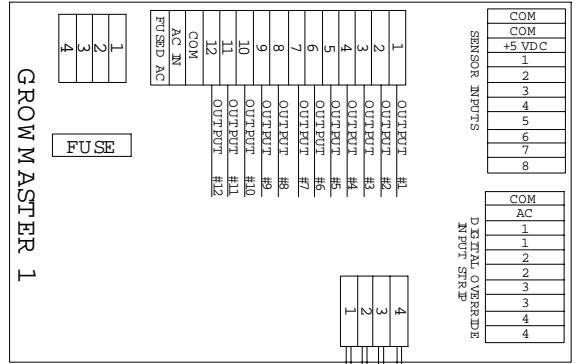

GROW LINK CONVERTOR BOX
 (LOCATED AT PC TERMINAL, INCLUDED WITH GROW LINK SOFTWARE PACKAGE)

TYPICAL WIRING FOR GROW LINK CONVERTOR BOX TO MULTIPLE GROW MASTERS

PHOTO COURTESY OF MICRO GREENHOUSE SYSTEMS, INC.

 <p>M I C R O G R O W G R E E N H O U S E S Y S T E M S , I N C . 26111 Ynez Road, Suite C-4 Temecula, CA 92591 Phone 909.296.3340 Fax 909.296.3350</p>	Project G R O W L I N K C O N V . B O X T O M U L T I G R O W M A S T E R S			
	Drawn by GH	Date 11/28/01	Distributor N/A	Order ID N/A

LIMITED WARRANTY

Micro Grow Greenhouse Systems, Inc. warrants that all of the products Micro Grow Greenhouse Systems, Inc. manufactures are free from defects at the time of shipment by Micro Grow Greenhouse Systems, Inc. This warranty covers defects in workmanship and materials. No warranty is extended on any parts, materials, or components manufactured by others and purchased by Micro Grow Greenhouse Systems, Inc., and any warranty on these materials is limited to the warranty supplied by the original manufacturer or supplier of said products only. This warranty excludes any and all damages cause by installation by unqualified individuals, damage by misuse or neglect, shipment damage, alterations to original manufacturing, and improper installation or use for any reason than intended by manufacturer. This warranty may not be altered in any manner except with the written authorization of one the officers or owners of Micro Grow Greenhouse Systems, Inc. The only and sole liability of Micro Grow Greenhouse Systems, Inc. under this warranty is limited to repairing, replacing or the issuance of credit for any products returned to Micro Grow Greenhouse Systems, Inc., during the warranty period of twelve (12) months from date of shipment. This warranty is specifically conditioned upon Micro Grow Greenhouse Systems, Inc. being notified in writing promptly upon discovery of any product defects by the buyer or end user. The product must then be returned prepaid to Micro Grow Greenhouse Systems, Inc. within the twelve month warranty period for inspection by Micro Grow Greenhouse Systems, Inc. Upon inspection of said product, Micro Grow Greenhouse Systems, Inc. will notify buyer or end user of its findings. At Micro Grow Greenhouse Systems, Inc. sole discretion, the product will be replaced, repaired or a credit will be issued for the original sale price of the product, provided that damage has not occurred due to misuse, neglect, improper use or installation as outlined above, shipping damages or accident.

MICRO GROW GREENHOUSE SYSTEMS, INC. SHALL NOT BE LIABLE FOR ANY DAMAGES BEYOND THE ACTUAL ORIGINAL COST OF THEIR PRODUCT EITHER DIRECTLY OR INDIRECTLY ARISING FROM DEFECTIVE PRODUCTS OR WORKMANSHIP.