



Ranger Series 2000

Quality....

- Superior strength rollformed arches, legs, and purlins insure unmatched structural integrity.
- The proven Gothic Arch design is engineered to reduce roof snow build-up and provide maximum headroom.

Flexibility....

- The Ranger Series 2000 is equally at home as a growing area or sophisticated garden center.
- Can be covered with polyethylene, shade cloth, or rigid coverings including polycarbonates.
- Available in 10 lb., 20 lb., or 30 lb. Snow loads.

Whether starting out or in an expansion mode, the versatility of the Ranger Series 2000 offers a natural no nonsense solution for obtaining maximum productivity while reducing capital investments.

Value....

- Rollformed components require substantially less labor to manufacture than conventional greenhouse designs.
- Components are shipped pre-punched and cut to length simplifying the installation.
- Rollformed components nest one onto the other, during shipment, substantially reducing freight rates.

Reliability...

- Some 50 years of experience go into each Ranger Series 2000 fabricated.
- Every detail has been field tested and refined to guarantee complete customer satisfaction.

Call Toll Free - 1-888-281-9337



Ranger Series 2000

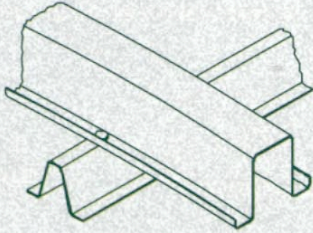

Arch and purlin design offer "I" beam technology for superior strength.

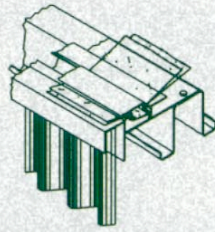

Aluminum end wall combination creates a flashing for end wall and roof coverings.

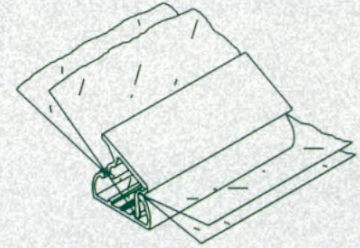

Tube Lock II is the most efficient means of securing poly coverings.

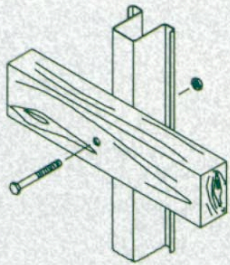

All legs are shipped pre-punched to simplify the installation of side wall framing (wood supplied by others).

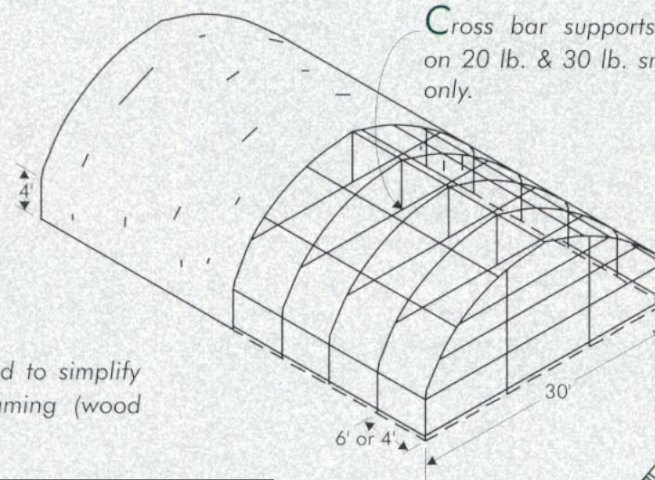

Cross bar supports supplied on 20 lb. & 30 lb. snow loads only.

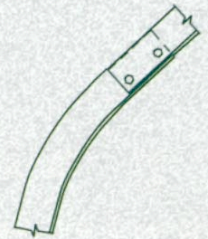

13 gauge rollformed legs are stronger than conventional greenhouse columns.

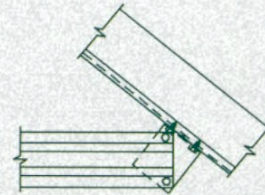

Galvanized steel end wall kits incorporate rollformed components for added strength.

Specifications

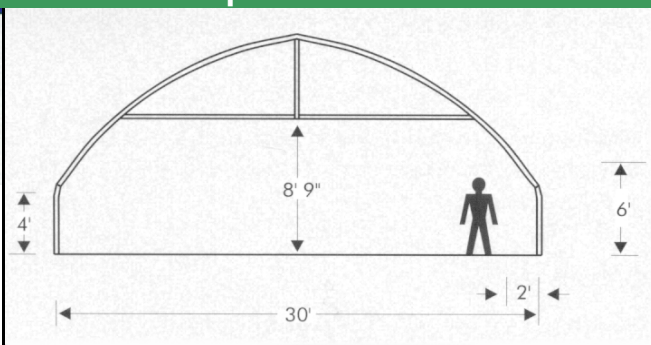

- | | |
|--|--|
| <ul style="list-style-type: none"> • 30' Wide—14' high at peak • Gothic Arch increases headroom—even at side walls • Adaptable to poly or rigid coverings | <ul style="list-style-type: none"> • Easily installed by owner • Compatible with all greenhouse environmental controls • Five purlins per house |
|--|--|

Accessory Equipment...

- Single or double roof vent assembly
- Rollup side or end wall curtains
- Rack & Pinion end wall vents
- Swing, sliding or rollup door assemblies
- Exhaust fans, circulation fans and evaporative cooling systems
- Space heaters, hot water heaters or radiant heat systems
- Stationary or rolling bench assemblies

International Greenhouse Company

Phone: 1-888-281-9337 - Fax: 1-217-288-9084
PO Box 79 - Sidell, IL 61876 USA